

# PV/wind distributed system for urban electrification: Techno-economic feasibility study

Naoual Seddaoui<sup>1</sup>, Hocine Belmili<sup>1</sup>, Lazhar Rahmani<sup>2</sup>

<sup>1</sup>Unité de Développement des Equipements Solaires, UDES, Centre de Développement des Energies Renouvelables, CDER, 42415, Tipaza, Algérie [nawelseddaoui@yahoo.com](mailto:nawelseddaoui@yahoo.com), [belmilih@yahoo.fr](mailto:belmilih@yahoo.fr)

<sup>2</sup>Laboratoire d'Automatique de Sétif, Département d'électrotechnique, Université de Sétif, Algérie  
[Lazhar\\_rah@yahoo.fr](mailto:Lazhar_rah@yahoo.fr)

## Abstract-

The present paper discusses the techno-economic feasibility of a microgrid PV/Wind distributed system to electrify urban area. The studied topology considered as a small-scale system, it consists of solar photovoltaic generator (GPV), small wind turbines (SWT) and storage tanks as subsystems. The produced energy link to a DC-bus and via inverters can supply different loads. The excess of energy is stored in batteries. The feasibility study to extend the distributed system to another microgrid is established, which depends greatly on the energy excess and the distance from this one. This study is performed by the sensitivity analysis of breakeven microgrid extension.

**Keywords** - Urban electrification, renewable energy, PV-Wind distributed System, microgrid, feasibility study.

## I.

### II. INTRODUCTION

Renewable energy sources such as wind and solar are becoming more affordable and viable alternatives for electricity generation. However, such sources when explored independently are not completely reliable because of the unpredictable nature. Today, new advances in technology and new directions in electricity regulation encourage a significant increase of hybrid distributed generation resources around the world. Distributed Generation systems, powered by micro sources such as fuel cells, photovoltaic cells, and wind turbines, have been gaining popularity among the industry and utilities due to their higher operating efficiencies, improved reliabilities, and lower emission levels [1].

Wind and solar power generation are two of the most promising renewable power generation technologies. The growth of wind and photovoltaic power generation systems has exceeded the most optimistic estimation. Nevertheless, because different renewable energy sources can complement each other, hybrid distributed systems have great potential to provide higher quality and more reliable power to customers than a system based on a single resource. Because of that, hybrid distributed systems have caught worldwide research attention [2].

The techno-economic analysis of the distributed systems is essential for the efficient utilization of renewable energy resources. The optimization of distributed renewable energy systems looks into the process of selecting the best components and its sizing with appropriate operation strategy to provide cheap, efficient, reliable and cost effective alternative energy. While the expected reliability from a stand-alone hybrid system constitutes an important criterion in optimization, the cost of the system is the governing factor. Therefore, relationship between the system reliability and cost should be closely studied so that an optimum solution can be attained [3].

For that, many researchers have studied PV-wind distributed energy systems that include system performance and cost analysis. Among these: Markvart has studied a PV/Wind hybrid system and determined the sizes of the PV array and wind turbine, by using the measured values of solar and wind energy at a given location [4]. Another technique for the sizing of stand-alone hybrid photovoltaic-wind systems has been developed by Bagul et al. [5]. This technique has important advantages over the original three event techniques: A probabilistic approach is used to get to the results. A general method has been developed to determine the sizing and the operation control of hybrid systems. The operation control and sizing selection method is based on genetic optimization techniques [6]. Kellogg et

al. have developed a numerical algorithm for generation unit sizing hybrid PV/wind power generating as stand-alone systems [7]. Marwali et al. proposed a methodology for cost calculating production of hybrid systems [8]. Also a probabilistic performance assessment method was developed by Karaki et al. [9]. A techno-economic analysis for stand-alone PV/wind hybrid energy system is presented by Celik [10]. Also, neural network and genetic algorithm may be used and combined for sizing and controlling hybrid energy system to giving optimum solution [11,12]. A detailed sizing method of stand-alone Photovoltaic–Wind hybrid systems is proposed and evaluated by the design and the development of flexible software basing on techno-economic analysis and using Object-Oriented Programming is proposed by Belmili et al. [13]. The optimal sizing of a standalone hybrid system that enables the minimization of the cost was implemented by Koutroulis et al., using genetic algorithms [14]. According to their results, it was verified that hybrid solar-wind systems lower the system costs in comparison with the solar/wind only systems.

In this paper, a laboratory-scale distributed system realized in the research unit (*Unité de Développement des Equipements Solaires*, UDES) located in BouIsmaïl/Tipaza, north of Algeria is presented and described. Its objective is to demonstrate the feasibility of a PV/wind stand-alone system. Since the distributed system can either be stand-alone or grid-connected, the integration of the existing system is proposed. For distributed generation systems the most important concern is to achieve the lowest energy cost, and the economical approach can be the best benchmark of cost analysis. The system under study has been analysed using the software tool hybrid optimization model for electric renewable HOMER. It is most widely used, freely available and user friendly software. The software is suitable for carrying out quick prefeasibility, optimization and sensitivity analysis in several possible system configurations [3, 15].

### III. SYSTEM CONFIGURATION

The system architecture and energy flow for the hybrid distributed PV/wind system is shown in Fig. 1. The system considered as case study mainly consists of PV arrays, wind turbine, battery bank, inverter, and controllers. The DC power output from the DC bus is converted into AC by the inverter to supply the base load. While available excess energy is fed into the battery bank which releases power to the load when the renewable energy output is unavailable or is insufficient to supply the load.

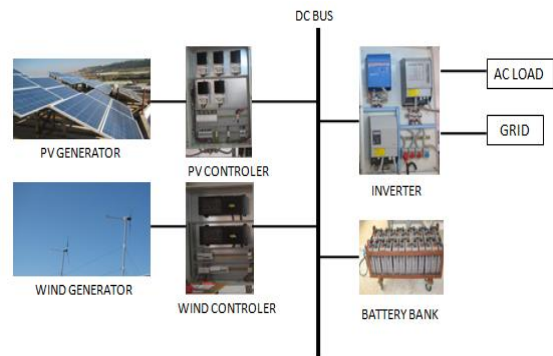

Fig. 1 PV/wind distributed system architecture

#### A. Photovoltaic subsystem:

The PV field located on the roof of the laboratory is mounted on a metal structure. It consists of 30 polycrystalline panels (*Suntech STP135-12/Tb*) [16], grouped into 05 parallel strings. Each string contains 06 PV modules in series resulting total capacity of 4kW peak and it is connected to a *TriStar MPPT 45* which works as a DC/DC converter and a battery charge controller at the same time, it is characterized by  $V_{MAX}=150V$ ,  $I_{MAX}=45A$ , and  $V_{output}=48V$  [17]. The electrical characteristics of a *Suntech STP135-12/Tb* PV module are given in TABLE I [16].

TABLE I. ELECTRIC CHARACTERISTICS OF PV STP135-12/Tb MODULE

PV module	STP135-12/Tb
Open circuit voltage (Voc)	22.3V
Voltage at maximum power (Vmp)	17.5V
Short circuit current (Isc)	8.20A
Current at maximum power (Imp)	7.71A
maximal power in STC (Pmax)	135Wp
Operational temperature	-40°C to +85°C
system maximum voltage	1000V DC

The I(V) characteristic of the photovoltaic module obtained under MATLAB software using manufacturer data is given in Fig. 2.

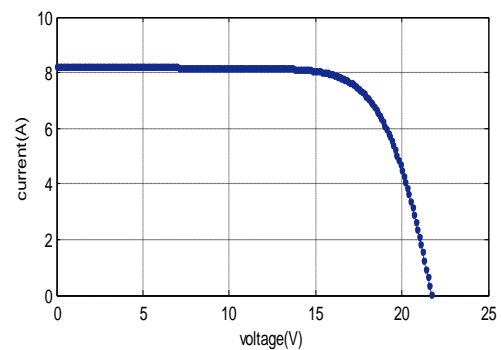

Fig. 2 Suntech STP135-12/Tb I(V) characteristic.

#### B. Wind subsystem

The system consists of two *Whisper 200* wind turbines (based on MSAP) with a rated power of 1kW for each one [18]. To provide the safest, secure and productive wind generator operation a *Whisper 200* wind charge controller is provided with each wind turbine and it is characterized by  $V_{output}=48V$  and  $I_{MAX}=45A$  [19]. Technical characteristics of *Whisper200* wind turbine are summarized in TABLE II [18].

TABLE II. TECHNICAL DATA OF WHISPER200

Characteristics	Whisper200
Rotor Diameter	2,7m
Weight	39.46 kg
Startup speed of the wind	3,1m/s
Maximum wind speed	55 m/s
Nominal power	1000W
Material	marine quality Aluminum
Blades	In carbon reinforced with glass fiber
Blades numbers	3
Wind protection	Side-Furling
Warranty	5 years

To estimate the power produced by the wind generator, characteristic power curve provided by the manufacturer is used. This curve is specific for each wind turbine; it allows knowing the produced power from wind speed.

Fig.3 illustrates the *Whisper 200* power curve obtained under MATLAB software, using manufacturer data.

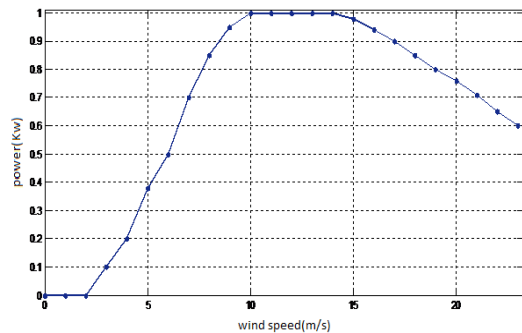

Fig. 3 *Whisper 200* Power curve.

### C. Battery bank

For the energy storage, *OPZS solar 190* classic stationary batteries are used [20]. Due to their robustness, long design life (10 years) and high operational safety they are ideally suitable for use in solar and wind power stations, telecommunication, power distribution companies, railways and many other safety equipment power supplies. Technical characteristics of *OPZS solar 190* battery are illustrated in TABLE III [20].

TABLE III. TECHNICAL CHARACTERISTICS OF *OPZS SOLAR 190* BATTERY

Type	OpzS Solar 190
Nominal voltage	2V
Nominal capacity of C120 (U=1,85V	190Ah

/cell for 25°C)	
Nominal capacity of C10 (U=1,85V / cell for 25°C)	128 Ah
Internal resistance	1,45
Short circuit Current	1400 A
Number of output	1
Lifetime	10years

### D. inverter

To serve the AC load the inverter is required to convert DC power to AC power. Three types of inverters are used:

- *HPC 48-6000* inverter for the photovoltaic subsystem.
- *Victron Phoénix 48-3000* inverter for the wind subsystem.
- *XPC-8000* inverter for the hybrid system.

This configuration provides more flexibility and modularity to our platform, it also allows studies on different subsystems separately photovoltaic alone, wind alone or the whole hybrid system

## IV. METEOROLOGICAL RESOURCES

Solar and wind data are obtained from the meteorological station in UDES (*Unité de Développement des Equipements Solaires*) /Boulsmail.

### 1. Solar resource

It can be seen from Fig. 2 that more solar radiation is expected from the month of April to September whereas from October to Mars the solar radiation is minimal.

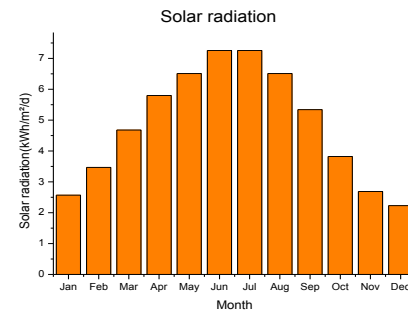

Fig.4 Average annual radiation in UDES

### 2. Wind resource

The annual average wind speed of the area is 3.7 m/s. Fig. 3 shows the wind speed profile for the annual period. The highest monthly mean wind speed of 4 m/s was observed in December, February, Mars, and April while a minimum of 3.4m/s is observed in May, September and October.

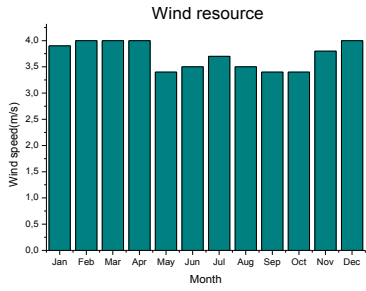

Fig.5 Average annual wind speed in UDES

### 3. Load demand

In this study, multi-source laboratory installed on the roof of UDES in Boulsmail was selected as a case study. The average daily energy consumed by the selected area is 8.6 kWh/day with 1.2 kW peak demand.

The daily load profile introduced into the Homer which corresponds to a daily consumption of the multi-source laboratory is shown in Fig. 4.

It can be seen that the maximum demand occurs during a daytime from 9 to 17 which corresponds to the working hours in the laboratory.

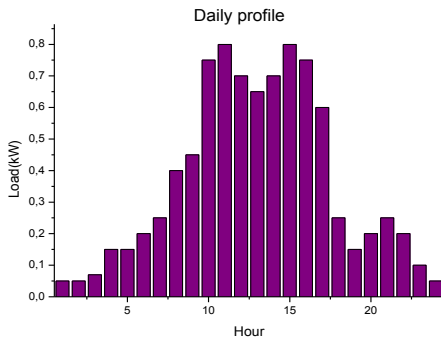

Fig.6 Daily Load profile

## V. OPTIMIZATION RESULTS

The analysis on the PV/wind distributed system in terms of economic viability is based on market prices and on financial evaluation techniques by means of the calculation of the Net Present Cost of energy consumed (NPC). It is the present value of all the costs that it incurs over its lifetime, minus the present value of all the revenue that it earns over its lifetime. Costs include capital costs, replacement costs, O&M costs, fuel costs, emissions penalties, and the costs of buying power from the grid. Revenues include salvage value and grid sales revenue [21 22].

HOMER assesses the technical feasibility of the hybrid system by determining whether the system can serve the load adequately. Then, it estimates the NPC of the system and ranks all the systems according to total NPC [23].

### 1. Stand-alone PV/wind system

Fig.7 gives a schematic representation of HOMER implementation of the PV/wind distributed system.

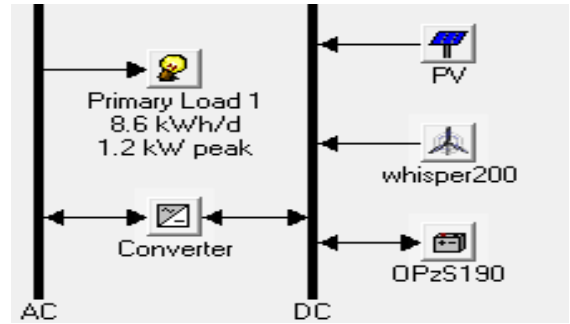

Fig.7 The stand-alone PV/wind system configuration in HOMER

Optimized results for the stand-alone PV/wind distributed system is presented in Fig. 8. Since the optimum configuration of the proposed system is stored, it is therefore easy to obtain the optimum sizing of the system.

	PV (kW)	wh200	OPzS190	Conv. (kW)	Initial Capital	Operating Cost (\$/yr)	Total NPC	COE (\$/kWh)	Ren. Frac.	Batt. Lf. (yr)
1	3	2	24	6	\$49,576	1,236	\$66,585	1.603	1.00	20.0
2	4	2	24	6	\$57,229	1,236	\$74,238	1.787	1.00	20.0

Fig.8 Optimized results for PV/wind stand-alone system

It can be seen that the first optimized result shows that the system comprised of 3 kW of PV panel, 2 kW wind turbine with 6 kW of converter and 24 batteries which gives total Net Present Cost of energy 66,585 \$. The Second optimized result shows a system with 4kW of PV system and 2 kW wind turbine and total Net Present Cost of energy 74.238\$. Looking at the values of NPC, we can easily see that the first optimized system has the lowest NPC of 66,585 \$ then it can be considered as the optimal system.

Fig. 9 summarizes the Net Present cost of each component and of the whole stand-alone PV/wind system throughout the lifetime of the project which is 25 years.

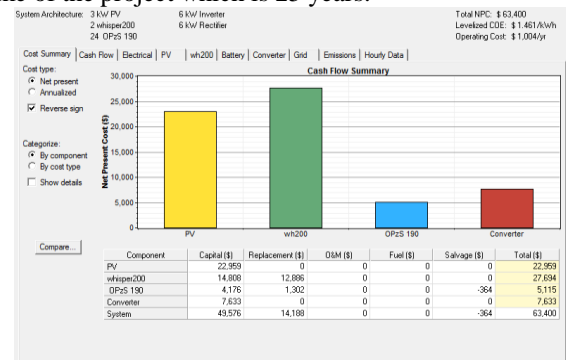

Fig.9 Net Present Cost of the stand-alone PV/wind system

This optimal system uses 100% renewable energy, with 65% of electricity comes from solar radiation, and 35% of electricity comes from wind source as it is shown in figure 10.

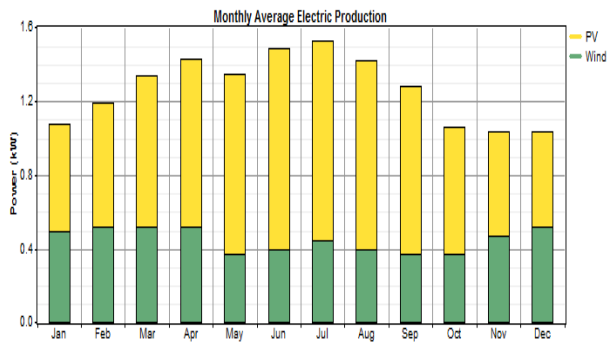

Fig.10 Monthly average electric production

## 2. PV/wind Grid connected system

Optimized result for PV/wind distributed system is presented in Fig. 11

	PV (kW)	wh200	OPzS190	Conv. (kW)	Grid (kW)	Initial Capital	Operating Cost (\$/yr)	Total NPC	COE (\$/kWh)	Net Purchases (kWh/yr)	Plan. Frac.	Batt. Lf. (yr)
1	3	2	24	8	0	\$ 49,576	882	\$ 61,711	1.422	-6,137	1.00	20.0
2	4	2	24	8	0	\$ 57,229	843	\$ 68,830	1.586	-8,077	1.00	20.0

Fig.11 Optimized results for PV/wind grid connected system

Fig.11 presents the optimized results of the PV/wind grid connected system and Fig.12 summarizes the Net Present cost of each component and of the whole PV/wind grid connected system.

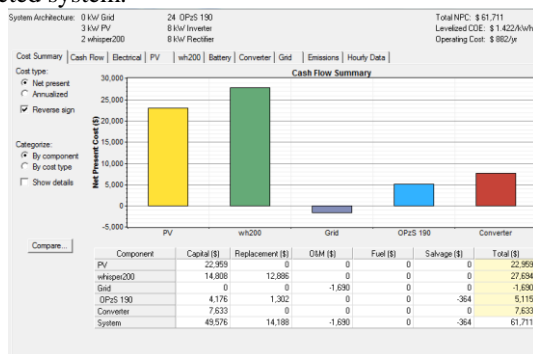

Fig.12 Net Present Cost of the grid connected PV/wind system

Comparing the optimization results of the two systems, (Fig.9, and Fig.12), it is illustrated that the total cost (NPC) of the stand-alone system is around 63.400 \$, while the cost of the grid connected system is estimated to be 61.711 \$ with a gain in cost of 1,689 \$. That is for small-scale plants, so this gain will be greater for large-scale power plants.

Fig.13 shows the total renewable power produced by the optimal PV/wind system during the month of January. For more details, an example of one week as shown in (Fig.14) is taken.

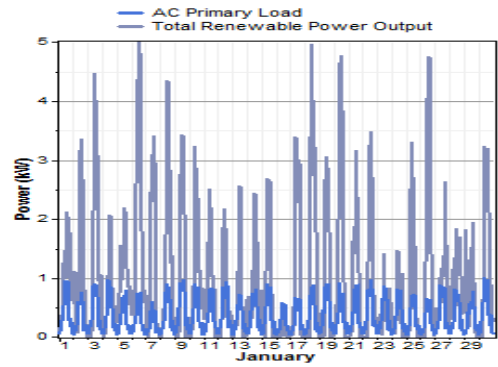

Fig.13 total renewable power produced in January.

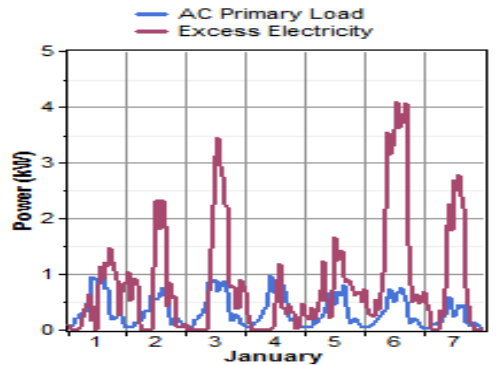

Fig.14 total renewable power produced in a week in January.

It can be seen that for 5 kW of total renewable production, less than 1kW (to 1.2 kW peak demand) is used to satisfy the load demand and about 3 kW to 4 kW is taken as an excess of energy. We have two solutions: either by increasing the storage bank capacity by adding more strings of batteries or by connecting the system to the utility grid [24].

Adding more batteries leads to more emissions and then an additional cost must be taking into account. Connecting the stand-alone system to the grid depends on the distance called the breakeven grid extension distance. At this distance the NPC of extending grid is equal to the stand-alone system NPC.

According to Sonelgaz data, Algerian National Society for Electricity and Gas [25], the cost of simple connection and grid extension is summarized in TABLE IV.

TABLE IV. COST OF SIMPLE CONNECTION AND GRID EXTENSION.

Distance(m)	Cost(\$/km)
d<25m	70 \$ to 100
d>25m	1200 to 1400

## VI. SENSITIVITY RESULTS

The feasibility of the distributed system depends greatly on the distance from the grid. By entering multiple values for the initial capital cost of the grid extension and for the annual cost of maintaining the grid extension a sensitivity analysis is performed.

Five discrete values of initial capital cost of the grid extension (1000, 1200, 1300, 1500, and 2000) \$/km and five discrete values of the annual cost of maintaining the grid extension (O&M) (100, 150, 200, 300, and 400) \$/y/km were used as sensitivity variables.

Fig.15 shows the sensitivity plot “a surface plot”, which plots the breakeven Grid extension distance versus both the grid capital cost and the annual cost of maintaining the grid extension (O&M).

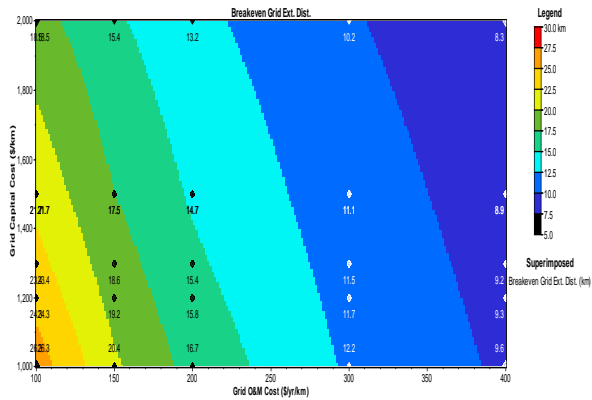

Fig.15 Sensitivity plot for breakeven grid extension

The line graphs shown below plot the grid extension cost versus grid extension distance (one output variable versus one single sensitivity variable). These are subsets of the results shown in the above surface plot, with a grid capital cost fixed at 2000 \$/km (Fig.16) and then fixed at 1000 \$/km (Fig.18).

The variation of the breakeven Grid extension distance versus the grid capital cost is also presented for fixed grid O&M cost at 400 \$/y/km (Fig.17) and then fixed at 100 \$/y/km (Fig.19).

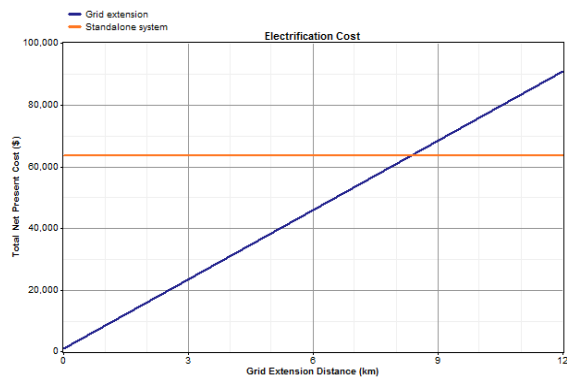

Fig.16 grid extension cost vs. grid extension distance

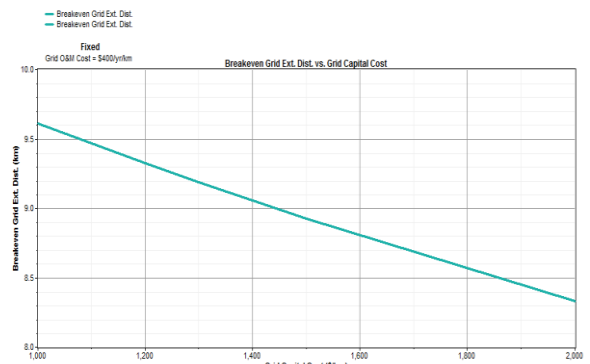

Fig.17 Breakeven grid extension vs. grid capital cost for fixed grid O&M cost=400 \$/y/km

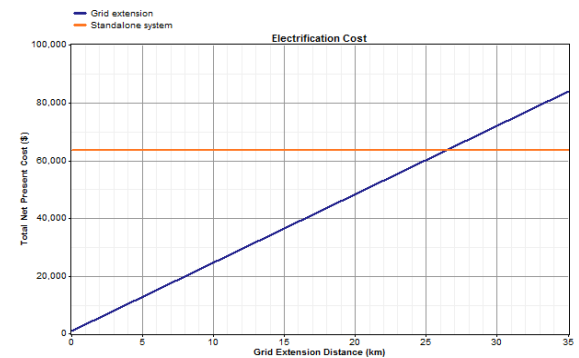

Fig.18 grid extension cost vs. grid extension distance

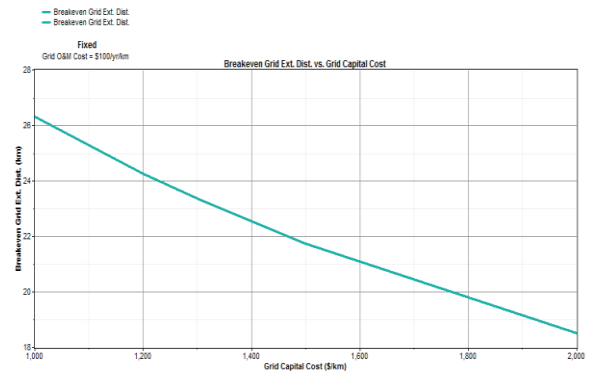

Fig.19 Breakeven grid extension vs. grid capital cost for fixed grid O&M cost=100 \$/y/km

The load can be supplied either by the stand-alone system or by the grid extension. The obtained graphs compare the costs of these two possibilities. It can be seen that the cost of the stand-alone system is independent of the grid extension distance, whereas the cost of extending the grid does depend on the grid extension distance. The distance at which the costs equate is the breakeven grid extension distance. Grid extension is the least-cost means of electrification up to distances of around 8.33km for capital cost equal to 1000

\$/km, and for annual cost of maintaining the grid extension (O&M) equal to 100 \$/y/km ( Fig.16,17). Where this is not the case, grid extension is least-cost up to distances of around 26.5 km where capital cost is around 2000 \$/km, and the annual cost of maintaining the grid extension equal to 400 \$/y/km (Fig. 18,19).

## VII. CONCLUSION

In this paper, the PV/wind distributed system architecture and components had been described. A detailed analysis at first stage of the system design based on the load demand is essential for reducing the system's cost. The analysis was performed in order to decide which optimization will be beneficial to cover the energy consumption taking into account the meteorological resources available in the city of BouIsmaïl, Tipaza, Algeria.

Comparing the optimization results of the stand-alone and the grid connected system; a gain in cost is illustrated in the second one. As a result, if there is the possibility of connecting renewable energy production to the grid it will be cheaper than a stand-alone system.

The feasibility of a distributed system to supply a load demand depends greatly on the distance from the grid. The results obtained from the sensitivity analysis show that grid extension is the least-cost means of electrification up to distances of 8.33 km, that for capital cost equal to 1000 \$/km and for (O&M) equal to 100 \$/yr/km. Where this is not the case, grid extension is least cost up to distances of 26.5 km where capital cost is around 2000 \$/km, and (O&M) equal to 400 \$/yr/km.

As a conclusion, farther away from the grid, the stand-alone system is optimal. Nearer to the grid, grid extension is optimal.

Finally, the optimization methodology described in this study provides a very important systematic approach to the design, analysis and optimization of distributed energy systems.

## REFERENCES

- [1] A.Hajizadeh, M.A.Golkar, "Intelligent Control of Fuel Cell Distributed Generation Systems", The 14th International Conference on Intelligent System Applications to Power Systems, Kaohsiung, Taiwan, November 4 – 8, 2007.
- [2] Kane M, Larrain D, Favrat D, Allani Y. "Small hybrid solar power system", *energy* 28, pp. 1427-1443, 2003.
- [3] Wei Zhou , Chengzhi Lou , Zhongshi Li , Lin Lu , Hongxing Yang, "Current status of research on optimum sizing of stand-alone hybrid solar-wind power generation systems", *Applied Energy* 87, pp.380-389, 2010.
- [4] T. Markvart. "Sizing of hybrid photovoltaic-wind energy systems" , *Sol Energy* 51, pp. 277-281, 1996.
- [5] D. Bagul, Z. Salameh, B. Borowy, "Sizing of a stand-alone hybrid wind-photovoltaic system using a three-event probability density approximation solar energy", *Renewable Energy* 56, pp 323-335, 1996.
- [6] H. Seeling GC, "A combined optimization concept for the design and operation strategy of hybrid-PV energy systems", *Sol Energy* 61, pp. 77-87, 1997.
- [7] W.D. Kellogg, M.H Nehrir, G. Venkataramanan, V.Gerez, "Generation unit sizing and cost analysis for stand-alone wind, photovoltaic, and hybrid wind/PV systems", *IEEE TransEnergy Convers* 13, 1998.
- [8] Marwali M.K.C, Shahidehpour SM, Daneshdoost M. "Probabilistic production costing for photovoltaic-utility systems with battery storage", *IEEE TransEnergy Convers* 12(2), pp. 175-180, 1997.
- [9] Karaki SH, Chedid RB, RamadanR. "Probabilistic performance assessment of autonomous solar-wind energy conversion systems", *IEEE TransEnergy Convers*14(2), 217-24, 1999.
- [10] Celik A.N ."Optimization and techno-economic analysis of autonomous photo-voltaic-wind hybrid energy systems in comparison to single photovoltaic and wind systems", *Energy Convers Manage*, 43(18), pp.2453-2468, 2002.
- [11] Mellit A, KalogirouSA, HontoriaL, Shaaris. "Artificial intelligence techniques for sizing photovoltaic systems: a review", *Renewable Sustainable Energy Rev* 13(2), 406-419, 2009.
- [12] Ramirez-RosadoJ, Bernal Agustin JL. "Genetic algorithm applied to the design of large power distribution systems", *IEEETrans PowerSyst* 13(2), 696-703, 1998.
- [13] Hocine Belmili, Mourad Haddadi, Seddik Bacha, Mohamed Fayçal Almi, Boualem Bendib, "Sizing stand-alone photovoltaic-wind hybrid system: Techno-economic analysis and optimization", *Renewable and Sustainable Energy Reviews* 30, pp. 821-832, 2014.
- [14] Koutroulis E, Kolokotsa D, Potirakis A, Kalaitzakis K. "Methodology for optimal sizing of stand-alone photovoltaic/wind-generator systems using geneticalgorithms". *Solar Energy* 80, pp.1072-1088, 2006.
- [15] S. Twaha, Z. Al-Hamouz, M. U. Mukhtiar , "Optimal Hybrid Renewable-Based Distributed Generation System with Feed-in Tariffs and Ranking Technique", *IEEE 8th International Power Engineering and Optimization Conference (PEOCO2014)*, Langkawi, The Jewel of Kedah, Malaysia, 24-25 March 2014.
- [16] Suntech STP135-12/Tb, available at <http://www.suntech-power.com>
- [17] <http://www.Morningstarcorp.com>
- [18] Southwest Windpower, Inc, *Renewable Energy Made Simple, Owners Manual, Installation, Operation and Maintenance*, January 2005.
- [19] <http://www.windenergy.com>
- [20] <http://www.solaris-store.com>
- [21] A. Kaabeche, Maiouf Belhamel, Rachid Ibtouen, "Techno-economic valuation and optimization of integrated photovoltaic/wind energy conversion system", *Solar Energy* 85, pp. 2407-2420, 2011.
- [22] Ali Naci Celik, "Techno-economic analysis of autonomous PV-wind hybrid energy systems using different sizing methods", *Energy Conversion and Management* 44, pp.1951-1968, 2003.
- [23] N. R. E. Lab. HOMER Guide, (20 October 2012).
- [24] Mehdi Dali , Jamel Belhadj, Xavier Roboam, "Hybrid solar-wind system with battery storage operating in grid-connected and stand-alone mode: Control and energy management Experimental investigation", *Energy* 35, pp. 2587-2595, 2010.
- [25] [www.sonelgaz.dz](http://www.sonelgaz.dz).